

The logo features the word "PANEP" in a bold, blue, sans-serif font. It is centered within a red graphic element consisting of two curved lines that form a partial circle around the text. The background of the entire page is a gradient of blue, with several overlapping, semi-transparent white and light blue curved shapes that create a sense of depth and movement.

**PANEP**

**PANEP STERISSET – SURGICAL ISOLATION PRODUCTS**

# PANEP STERISSET – SURGICAL ISOLATION PRODUCTS

PANEP STERISSET gives a compatible system of products allowing complete isolation of all potential contamination sources on the operating room. System consists of:

- Surgical drapes of various shapes and sizes equipped with the adhesive fields and fenestrations, with or without integrated tubing holders.
- Surgical gowns
- Instrument table and back table covers
- Covers for diagnostic and operating equipment
- Incision films
- Affixation aids
- Fluid collection bags and waste pouches
- Disposable trays, bowls, gallipots
- Syringes, needles, cannulas
- Disposable instruments
- Gloves
- Drying towels

## ZR Drapes (Zonal Reinforced Drapes):

These drapes are developed with focus on best functionality of critical and non-critical drape areas. On ZR Drapes are created different zones of optimised properties in consider to the level of charge during operation procedures.

### HP Zone (High Performance)

Critical drape area which is potentially under tension and wetting for a long time. Here are enhanced the tensile and bursting strength, absorbency and fluid resistance to get the highest level of infection control.

### SP Zone (Standard Performance)

Non-critical drape area potentially aside of continual charge. Enhanced properties are the drapeability and air permeability to get maximum level of safety and comfort for the patient and OR staff.

## Drapes SOFT

These drapes are made of soft 2-ply laminate. High absorbent non-woven fabric on the top brings an excellent fluid control over the whole surface. Soft and low-slide plastic film on the bottom gives the effective protection against penetration by fluids and microorganism. That composition makes the drapes highly safe and comfortable.

**PANEP STERISSET fully meets the requirements of European Standard EN 13795 part 1 – 3 for High performance products, critical area.**

**Compliance to this standard was evaluated by accredited laboratories TZÚ Brno (test report no. CHZ 07/0208, FZZ 07/0418 and CHZ 07/0488 and CENTEXBEL (test report no. YR/su/07/152)**

**PANEP**



# INDEX

SURGICAL DRAPES	5
ACCESSORIES	8
CUSTOMIZED SURGICAL SETS	10
SURGICAL SETS – GENERAL SURGERY	11
SURGICAL SETS – ORTHOPAEDIC SURGERY	13
SURGICAL SETS – GYNAECOLOGY & UROLOGY	19
SURGICAL SETS – CARDIOVASCULAR SURGERY	26
SURGICAL SETS – NEUROLOGY	27
SURGICAL SETS – CARDIOLOGY	28
SURGICAL SETS – OPHTHALMOLOGY	30
SURGICAL SETS – ENT SURGERY	33
CENTRAL VENOUS CATHETERIZATION SETS	34
NON-SURGICAL PROCEDURE SETS	35
SURGICAL GOWNS	40
DISPOSABLE APPAREL	41

## SURGICAL DRAPES

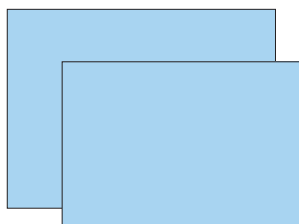

UTILITY DRAPES SOFT		
Art. No.	Item specification	Qty./box
38700	50 x 50cm	320
38701	50 x 70cm	320
38702	75 x 100cm	160
38703	100 x 120cm	120
38704	100 x 150cm	60
38705	150 x 200cm	50

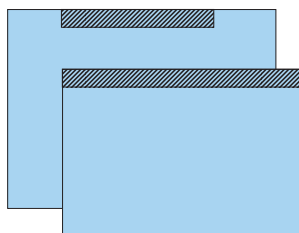

ADHESIVE EDGED DRAPES SOFT		
Art. No.	Item specification	Qty./box
38801	50 x 70cm	320
38802	75 x 100cm	160
38810	100 x 120cm	120
38807	100 x 150cm	60
38803	150 x 200cm	50

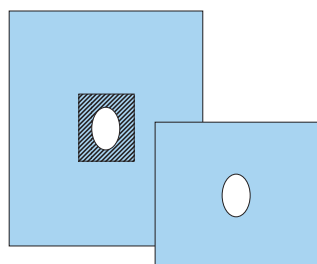

DRAPES SOFT CENTRAL FENESTRATED		
Art. No.	Item specification	Qty./box
38200	45 x 65 cm, fenestration $\varnothing$ 7,5cm (tissue / film)	300
38709	50 x 70 cm, fenestration 6 x 8cm	320
38201	75 x 100 cm, fenestration 6 x 8cm	200
38202	75 x 100 cm, fenestration 6 x 8cm, adhesive	200
38710	100 x 120 cm, fenestration $\varnothing$ 10cm	120

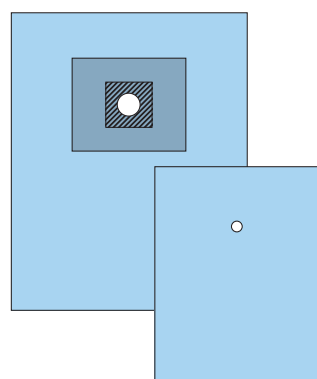

EXCENTRIC FENESTRATED DRAPES		
Art. No.	Item specification	Qty./box
38228	Drape SMS 120 x 170cm, fenestration $\varnothing$ 12cm	60
38223	Drape ZR 200 x 280cm, fenestration $\varnothing$ 10cm, adhesive	20
38224	Drape ZR 200 x 280cm, fenestration $\varnothing$ 15cm, adhesive	20

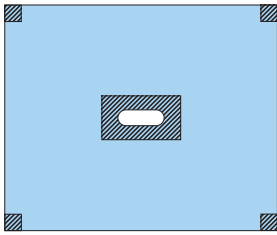

EPIDURAL DRAPE		
Art. No.	Item specification	Qty./box
38222	Drape SOFT 75 x 100cm, with fen. 6 x 15cm, adhesive field around the hole and on the corners	120

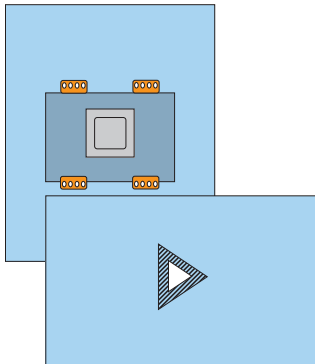

ABDOMINAL DRAPES		
Art. No.	Item specification	Qty./box
38302	Abdominal drape ZR 200x320 cm, fenestration 25 x 30cm with incise film	15
38313	Laparoscopy drape SOFT 200x320 cm, fenestration 25 x 30cm, adhesive	20
38316	Laparoscopy drape SOFT 200 x 300 cm, Δ fenestration 24 x 24 x 24cm, adhesive	20

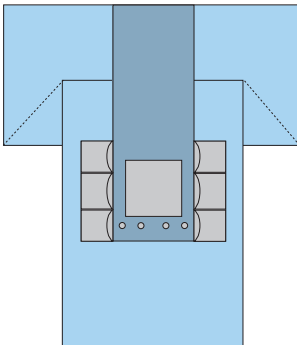

THORAX DRAPE		
Art. No.	Item specification	Qty./box
38321	T-shape drape ZR 260x320 cm with side instrument pockets and tubing holder. Abdominal fenestration 30x40cm with integrated incise film.	10

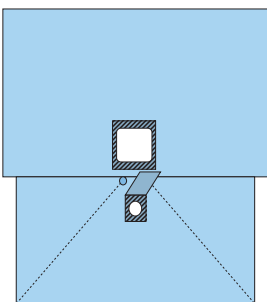

LAPAROSCOPY / PELVISCOPY DRAPE WITH INTEGRAL LEGGINGS		
Art. No.	Item specification	Qty./box
38514	Drape SOFT 250x280 cm, abdominal fenestration 30x30cm with adhesive edge, pelvis fenestration Ø 12cm covered with overlap.	15

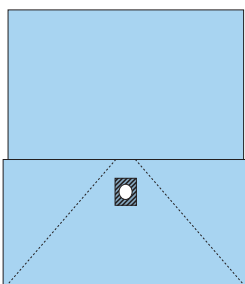

PELVISCOPY DRAPE WITH INTEGRAL LEGGINGS		
Art. No.	Item specification	Qty./box
38515	Drape SOFT 230 x 250 cm, pelvis fenestration Ø 12cm with adhesive edge.	20

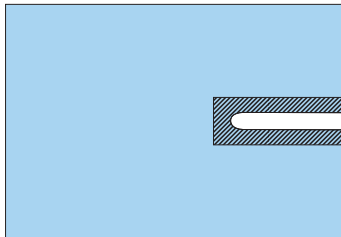

#### U-SPLIT DRAPES SOFT

Art. No.	Item specification	Qty./box
38341	U-split drape SOFT 150 x 200 cm, fen. 6 x 65 cm	40
38332	U-split drape SOFT 200 x 260 cm, fen. 8 x 80 cm	30

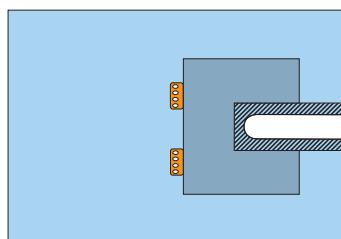

#### U-SPLIT DRAPES ZR

Art. No.	Item specification	Qty./box
38303	U-split drape ZR 150 x 200 cm, fen. 6 x 65 cm	25
38301	U-split drape ZR 200 x 260 cm, fen. 8 x 80 cm	20

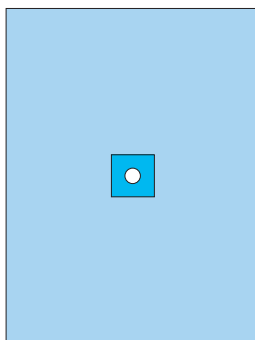

#### EXTREMITY DRAPES SOFT

Art. No.	Item specification	Qty./box
38339	Arthroscopy drape SOFT, 200 x 320 cm, with elastic fenestration 6 x 8 cm	20
38338	Extremity drape SOFT, 200 x 300 cm, with elastic fenestration $\varnothing$ 3,5 cm	20

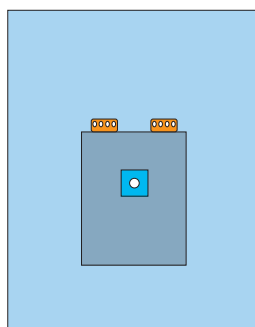

#### EXTREMITY DRAPES ZR

Art. No.	Item specification	Qty./box
38300	Arthroscopy drape ZR, 200 x 320 cm, with elastic fenestration 6 x 8 cm	15
38308	Extremity drape ZR, 200 x 300 cm, with elastic fenestration $\varnothing$ 3,5 cm	15

## ACCESSORIES

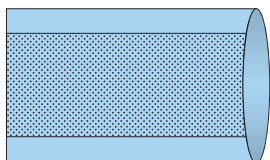

MAYO STAND COVERS		
Art. No.	Item specification	Qty./box
38900	80 x 140cm	80
38901	80 x 140cm, reinforced	60

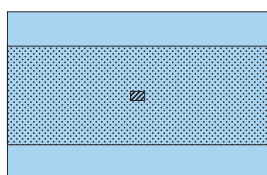
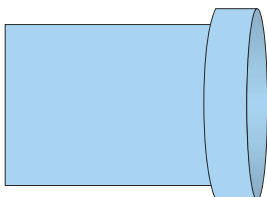

TABLE COVERS		
Art. No.	Item specification	Qty./box
38911	100 x 150cm	60
38912	150 x 190cm	70
38915	150 x 260cm	50



LEGGINGS		
Art. No.	Item specification	Qty./box
38923	Leggings ORTHO 33 x 60cm,	160
38920	Leggings ORTHO 33 x 80cm,	160
38921	Leggings ORTHO 33 x 120cm,	120
38925	Lithotomy leggings 70 x 120cm, 2 pcs / pack.	40



AFFIXATION AIDS		
Art. No.	Item specification	Qty./box
38931	OP-tape 10 x 50cm	200
38930	Self-adhesive Velcro, 2 x 22cm	200



CAMERA DRAPES		
Art. No.	Item specification	Qty./box
NKK142504S	COMFORT, 14 x 250 cm, with introduction card, telescoping folded	200



CABLE DRAPES		
Art. No.	Item specification	Qty./box
DC7120S	DENT-COVER 7 x 120 cm, with introduction card and elastic ring, zig-zag folded	200
DC7170S	DENT-COVER 7 x 170 cm, with introduction card and adhesive tape, zig-zag folded	200



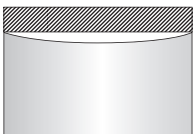
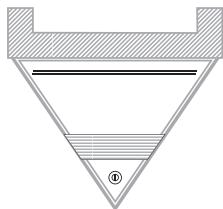
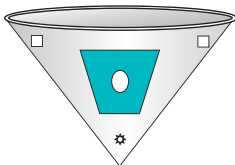
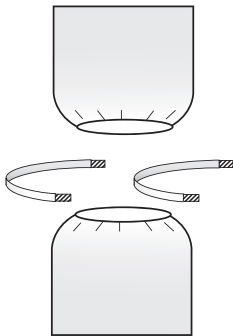
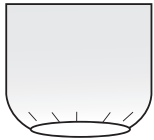
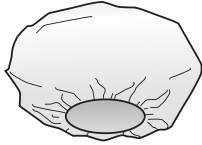

### COVERS FOR DEVICES

Art. No.	Item specification	Qty./box
NB6585S	65 x 85cm	100
NB8585S	85 x 85cm	100
NB105105S	105 x 105cm	100
NB120120S	120 x 120cm	100
NB140140S	140 x 140cm	100
BB7080S	70 x 80cm, flatt	100
BB90100S	90 x 100cm, flatt	100
BB80150S	80 x 150cm, flatt	100

### UNIVERSAL C-ARM SET

Art. No. SCR100160S

Units / box 20

Item specification	Pcs. / set
Top cover with elastic collar, 100 x 160cm	1
Bottom cover with elastic collar, 80 x 150cm	1
Affixation tape with adhesive edges, 3 x 100cm	2

### ARTHOSCOPY FLUID COLLECTION BAG

Art. No.	Item specification	Qty./box
AV60100S	60 x 100cm, with two elastic fenestrations, formable reinforcement and tubing port	20

### IRRIGATION POUCH

Art. No.	Item specification	Qty./box
SVF5050S	50 x 50cm, selfadhesive, with filter, formable reinforcement and tubing port	100

### FLUID COLLECTION / DIATHERMY POUCHES

Art. No.	Item specification	Qty./box
ZK4030-1S	30 x 40cm, 1-chamber	200
ZK6050-1S	50 x 60cm, 1-chamber	120
ZK4030S	30 x 40cm, 2-chamber	200

## CUSTOMIZED SURGICAL SETS

Respecting the individual needs of customers, PANEP offers the customized sets contenting complete range of disposable material needed for each of surgical procedures. That kind of sets brings the new benefits to the users:

**1 procedure = 1 set**

- Inventory control
- Control of procedure costs
- Standardization
- Flexibility
- Saves preparation time → increase of turnover
- Less handling of individual components
- Less waste
- Adapted to customer's individual needs



## SURGICAL SETS – GENERAL SURGERY

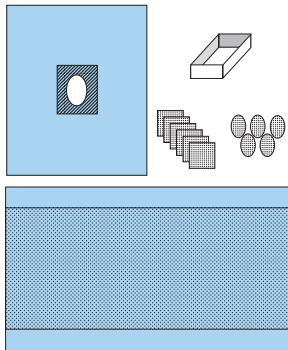

PROCEDURE SET SMALL Art. No. 42000 075		Units / box 45
Item specification	Pcs. / set	
Table cover, 100 x 120cm	1	
Adhesive drape SOFT, 75 x 100 cm with fenestration 6x8cm,	1	
Plastic tray	1	
Gauze swabs 10 x 10cm	10	
Gauze balls 30 x 30cm	5	

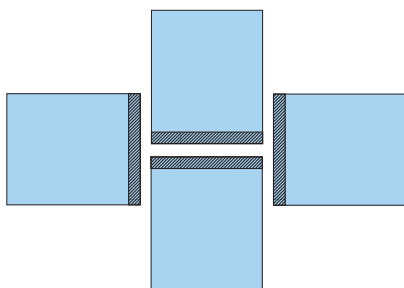

UNIVERSAL SET SMALL Art. No. 42000 011		Units / box 50
Item specification	Pcs. / set	
Adhesive drape SOFT, 75 x 100cm	4	

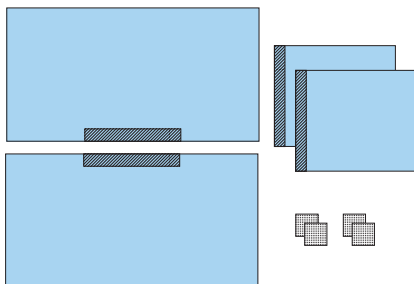

UNIVERSAL SET MEDIUM Art. No. 42000 012		Units / box 25
Item specification	Pcs. / set	
Adhesive drape SOFT, 150 x 200cm	2	
Adhesive drape SOFT, 75 x 100cm	2	
Hand towel	4	

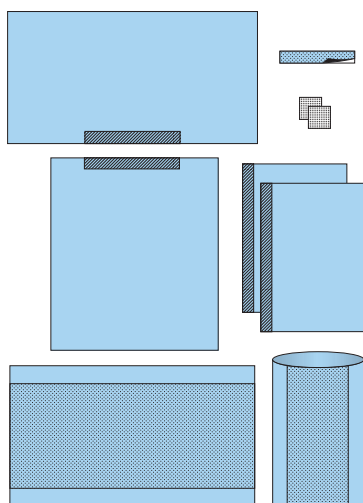

UNIVERSAL SET SOFT Art. No. 42000 900		Units / box 20
Item specification	Pcs. / set	
Table cover, 150 x 200cm	1	
Mayo stand cover, 80 x 140cm	1	
Adhesive drape SOFT, 150 x 200cm	1	
Adhesive drape SOFT, 150 x 240cm	1	
Adhesive drape SOFT, 75 x 100cm	2	
OP-tape 10x50cm	1	
Hand towel	2	

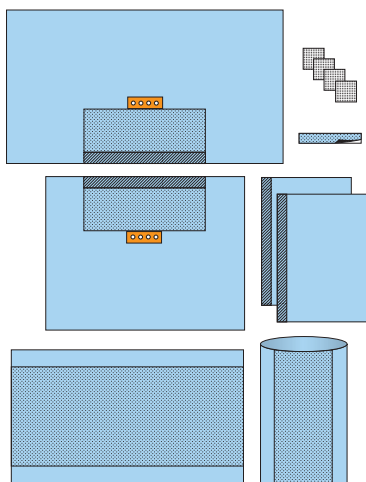

<b>UNIVERSAL SET LARGE</b> Art. No. 42000 001		Units / box 12
<b>Item specification</b>		<b>Pcs. / set</b>
Table cover, 150 x 190cm		1
Mayo stand cover, 80 x140 cm		1
Adhesive drape ZR with cable holder, 160 x 180cm		1
Adhesive drape ZR with cable holder, 160 x 240cm		1
Adhesive drape ZR, 80 x 90cm		2
OP-tape, 10 x 50cm		1
Hand towel		4

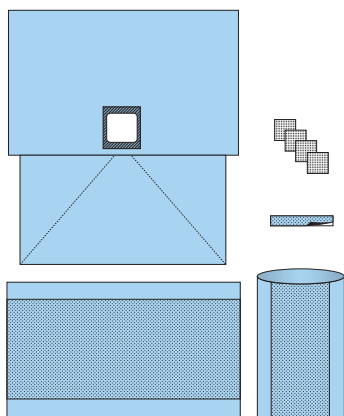

<b>ABDOMINAL SET WITH INTEGRAL LEGGINGS</b> Art. No. 42001163		Units / box 12
<b>Item specification</b>		<b>Pcs. / set</b>
Table cover, 150 x 200cm		1
Mayo stand cover, 80 x 140 cm		1
Drape SOFT 250x280 cm, abdominal fenestration 30x30cm with adhesive edge		1
OP-tape, 10 x 50cm		1
Hand towel		4

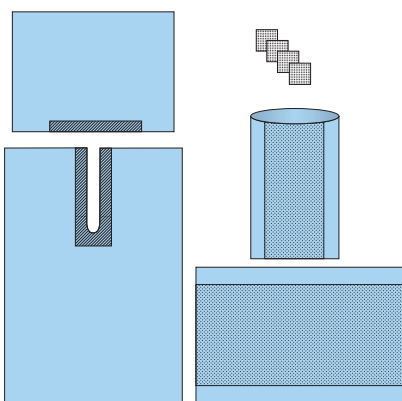

<b>VARIX SET</b> Art. No. 42000 079		Units / box 12
<b>Item specification</b>		<b>Pcs. / set</b>
Table cover, 150 x 200cm		1
Mayo stand cover, 80 x 140 cm		1
U-split drape SOFT, 200 x 260cm, fen. 8,5 x 80 cm		1
Adhesive drape SOFT, 150 x 200cm		1
Hand towel		4

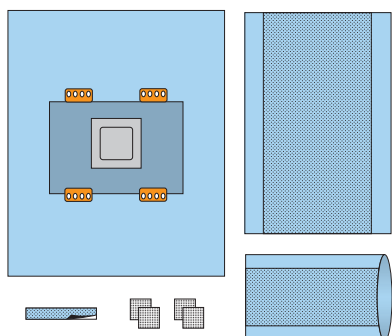

<b>ABDOMINAL SET</b> Art. No. 42000 080		Units / box 12
<b>Item specification</b>		<b>Pcs. / set</b>
Table cover, 150 x 190cm		1
Mayo stand cover, 80 x 140 cm		1
Abdominal drape ZR 200 x 320 cm, fen. 25 x 30 cm with incise film		1
OP-tape, 10 x 50cm		1
Hand towel		4

## SURGICAL SETS – ORTHOPAEDIC SURGERY

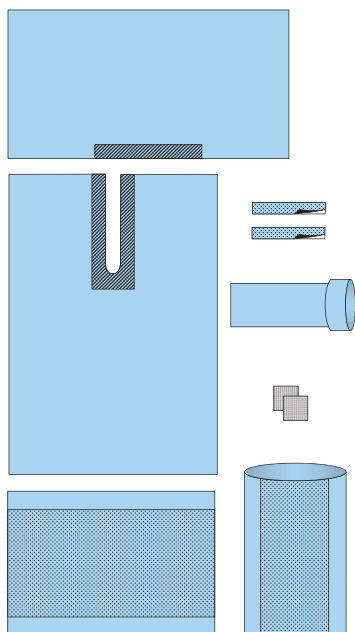

HIP SET - SOFT Art. No. 42001151		Units / box 10
Item specification		Pcs. / set
Table cover, 150 x 190cm		1
Mayo stand cover, 80 x 140 cm		1
U-split drape SOFT, 200 x 260cm, fen.8,5 x 80cm		1
Adhesive drape SOFT, 165 x 300cm		1
Leggings, 35 x 120cm		1
OP-tape, 10 x 50cm		2
Hand towel		2

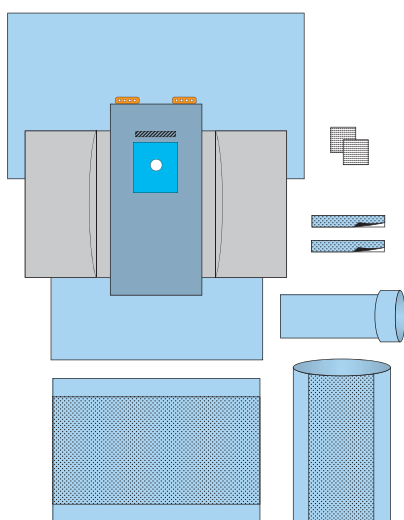

HIP SET – SIDE POSITION Art. No. 42000495		Units / box 6
Item specification		Pcs. / set
Table cover, 150 x 190cm		1
Mayo stand cover, 80 x 140 cm		1
Drape ZR 300x380cm with elastic fenestration Ø 15cm, side bags and cable holder		1
Leggings, 35 x 120cm		1
OP-tape, 10 x 50cm		2
Hand towel		2

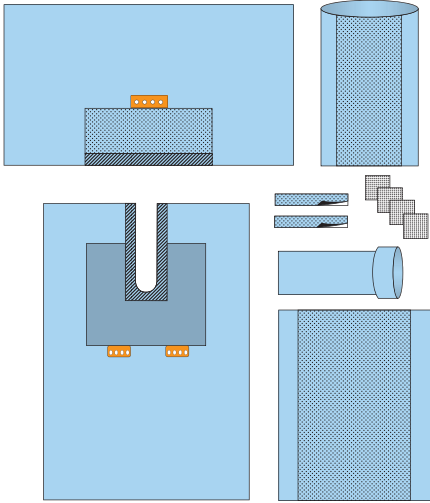

HIP SET I Art. No. 42000 003		Units / box 8
Item specification		Pcs. / set
Table cover, 150 x 190cm		1
Mayo stand cover, 80 x 140 cm		1
U-split drape ZR 200 x 260cm with cable holders, fen. 8 x 80cm		1
Adhesive drape ZR with cable holder, 160 x 240cm		1
Leggings, 35 x 120cm		1
OP-tape, 10 x 50cm		2
Hand towel		4

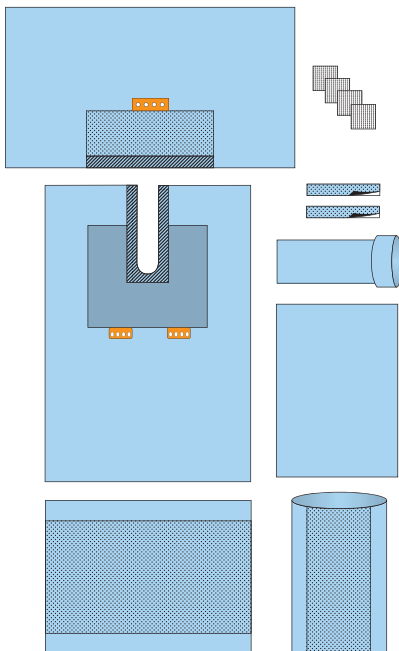

HIP SET II Art. No. 42000049		Units / box 8
Item specification		Pcs. / set
Table cover, 150 x 190cm		1
Mayo stand cover, 80 x 140 cm		1
U-split drape ZR 200 x 260cm with cable holders, fen. 8 x 80cm		1
Adhesive drape ZR with cable holder, 160 x 300cm		1
Adhesive drape, 150 x 200cm		1
Leggings, 35 x 120cm		1
OP-tape, 10 x 50cm		2
Hand towel		4

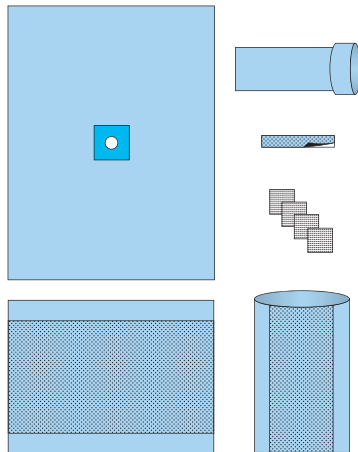

<b>KNEE SET - SOFT</b> Art. No. 42001153		Units / box 12
<b>Item specification</b>		Pcs. / set
Table cover, 150 x 190cm		1
Mayo stand cover, 80 x 140 cm		1
Knee drape SOFT 200 x 320cm, elastic fenestration 6x8cm		1
Leggings, 30 x 60cm		1
OP-tape, 10 x 50cm		1
Hand towel		4

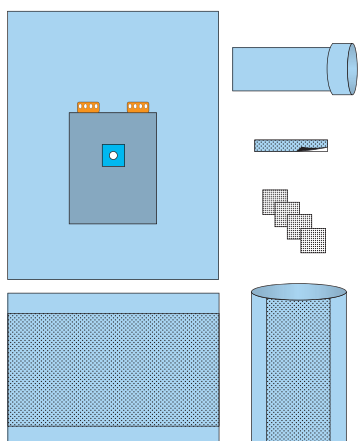

<b>KNEE SET - ZR</b> Art. No. 42000 002		Units / box 12
<b>Item specification</b>		Pcs. / set
Table cover, 150 x 190cm		1
Mayo stand cover, 80 x 140 cm		1
Arthroscopy drape ZR 200 x 320 cm, with elastic fenestration 6 x 8 cm		1
Leggings, 30 x 60cm		1
OP-tape, 10 x 50cm		1
Hand towel		4

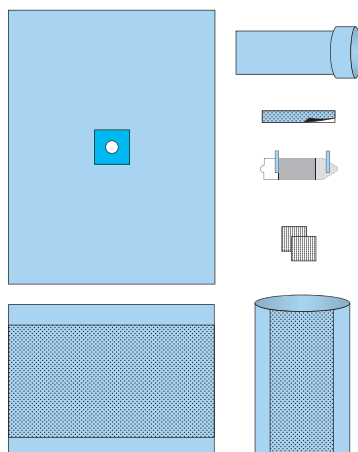

<b>ARTHROSCOPY SET SOFT</b> Art. No. 42000240		Units / box 15
<b>Item specification</b>		Pcs. / set
Table cover, 150 x 200cm		1
Mayo stand cover, 80 x 140 cm		1
Leggings, 30 x 60cm		1
OP-tape, 10 x 50cm		1
Knee drape SOFT 200 x 320cm, elastic fenestration 6x8cm		1
Camera drape, telescopic folded, 14 x 250cm		1
Hand towel		2

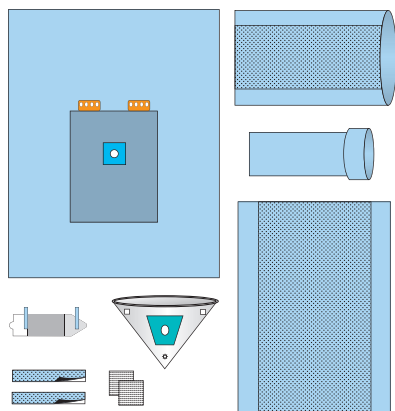

ARTHROSCOPY SET WITH F/C BAG Art. No. 42000 082		Units / box 10
Item specification		Pcs. / set
Table cover, 150 x 190cm		1
Mayo stand cover, 80 x 140 cm		1
Leggings, 30 x 60cm		1
OP-tape, 10 x 50cm		2
Arthroscopy drape ZR 200 x 320 cm, with elastic fenestration 6 x 8 cm		1
Fluid collection bag, 60 x 100cm		1
Camera drape, telescoping folded, 14 x 250cm		1
Hand towel		2

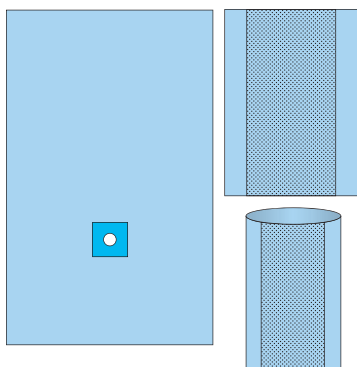

EXTREMITY SET SOFT Art. No. 420001152		Units / box 15
Item specification		Pcs. / set
Table cover, 150 x 200cm		1
Mayo stand cover, 80 x 140 cm		1
Extremity drape SOFT 200 x 300cm, with elastic fenestration ø3,5 cm		1

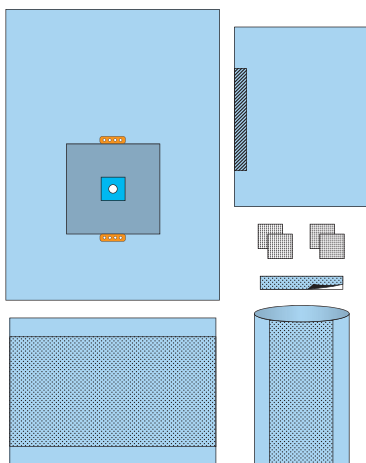

KONČETINOVÝ SET - ZR Art. No. 42000 081		Units / box 10
Item specification		Pcs. / set
Table cover, 150 x 190cm		1
Mayo stand cover, 80 x 140 cm		1
Extremity drape ZR 200 x 300 cm, with elastic fenestration ø 3,5 cm		1
Adhesive drape ZR, 170 x 200cm		1
OP-tape, 10 x 50cm		1
Hand towel		4



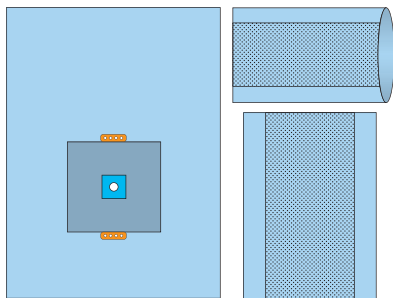

<b>HALLUX SET</b>	
Art. No. 42000 083	
Units / box 12	
Item specification	Pcs. / set
Table cover, 150 x 190cm	1
Mayo stand cover, 80 x 140 cm	1
Extremity drape ZR 200 x 300 cm, with elastic fenestration ø 3,5 cm	1

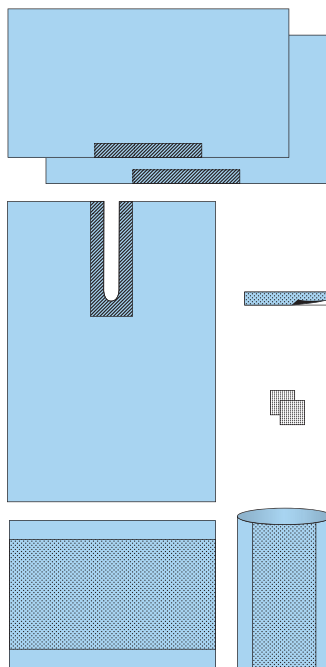

<b>SHOULDER SET SOFT</b>	
Art. No. 42001173	
Units / box 12	
Item specification	Pcs. / set
Table cover, 150 x 190cm	1
Mayo stand cover, 80 x 140 cm	1
U-split drape SOFT, 200 x 260cm, fen. 8,5 x 80 cm	1
Adhesive drape SOFT, 150 x 200cm	2
OP-tape, 10 x 50cm	1
Hand towel	2

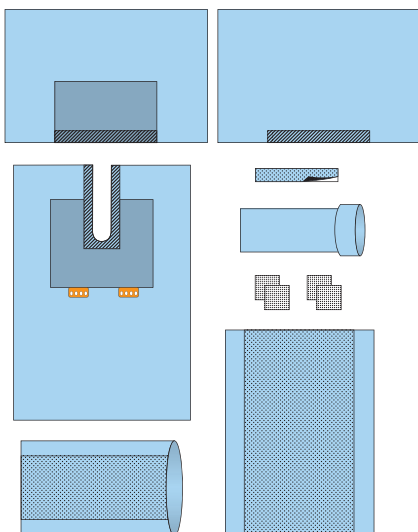

<b>SHOULDER SET ZR</b>	
Art. No. 42000 054	
Units / box 8	
Item specification	Pcs. / set
Table cover, 150 x 190cm	1
Mayo stand cover, 80 x 140 cm	1
U-split drape ZR 200 x 260cm with cable holders, fen. 8 x 80cm	1
Adhesive drape SOFT, 150 x 200cm	1
Adhesive drape ZR, 160 x 180cm	1
Leggings, 30 x 60cm	1
OP-tape, 10 x 50cm	1
Hand towel	4

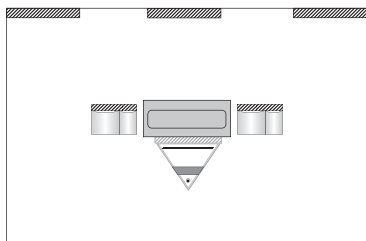

**VERTICAL DRAPE**

Art. No.	Item specification	Qty./box
38950	Vertical drape 240 x 330cm with fluid collection pouch, two side pockets and integrated incise film fenestration 25 x 45cm	20

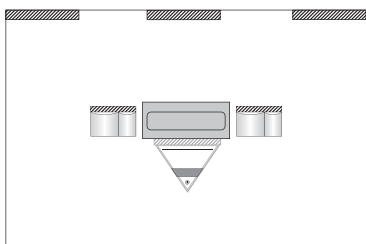

**VERTIKÁLNÍ SET**

Art. No. 42000 413

Item specification	Units / box 12
Table cover, 150 x 190cm	1
Mayo stand cover, 80 x 140 cm	1
Vertical drape 240 x 330cm with fluid collection pouch, two side pockets and integrated incise film fenestration 25 x 45cm	1
Hand towel	4

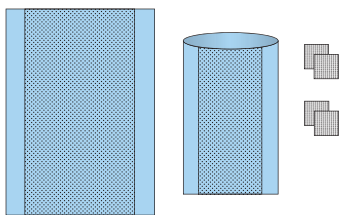

## OPERATING SETS – GYNAECOLOGY & UROLOGY

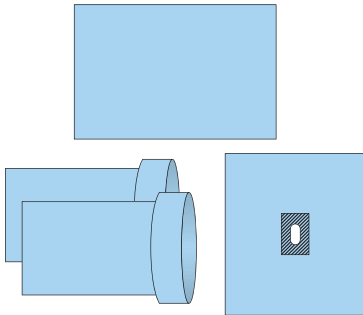

<b>CYSTOSCOPY SET SMALL</b> Art.No. 42000 086		Units / box 20
<b>Item specification</b>		<b>Pcs. / set</b>
Table cover SOFT, 75 x 100cm		1
Leggings, 70 x 120 cm		2
Fenestrated drape SOFT, 75 x 100cm, fen. 6 x 8cm, selfadhesive		1

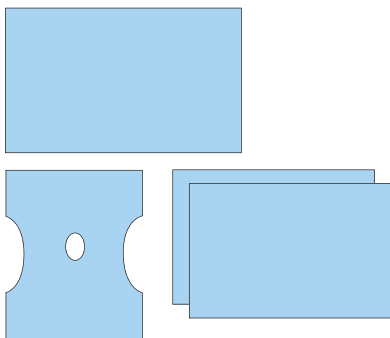

<b>CYSTOSCOPY SET SOFT</b> Art.No. 42001147		Units / box 50
<b>Item specification</b>		<b>Pcs. / set</b>
Table cover SOFT, 75 x 100cm		1
Drape SOFT, 70 x 120 cm		2
Shaped drape SOFT, 100 x 120cm, fenestration 6 x 8cm		1

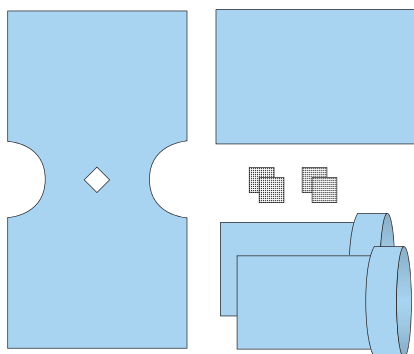

<b>UROLOGY / GYNAECOLOGY SET BASIC</b> Art.No. 42000 414		Units / box 15
<b>Item specification</b>		<b>Pcs. / set</b>
Table cover SOFT, 100 x 120cm		1
Leggings, 70 x 120 cm		2
Shaped drape SOFT, 75 x 200cm, fenestration 8 x 12cm		1
Hand towel		4

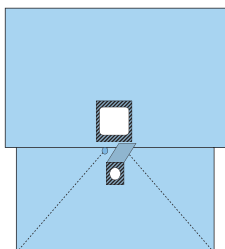

LAPAROSCOPY / PELVISCOPY DRAPE WITH INTEGRAL LEGGINGS		
Art. No.	Item specification	Qty./box
38514	Drape SOFT 250x280 cm, abdominal fen. 30x30cm with adhesive edge, pelvis fenestration Ø 12cm covered with overlap.	15

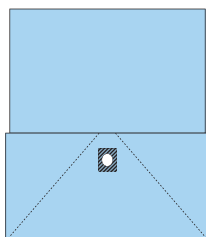

GYNAECOLOGY DRAPE WITH INTEGRAL LEGGINGS		
Art. No.	Item specification	Qty./box
38515	Drape SOFT 230x250 cm, pelvis fenestration Ø 12cm with adhesive edge.	20

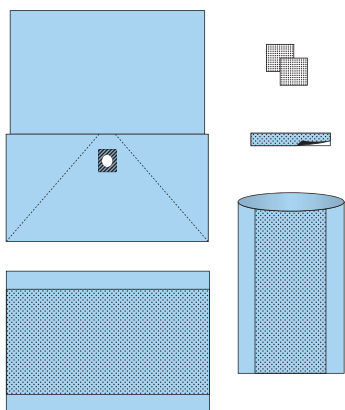

GYNAECOLOGY SET WITH INTEGRAL LEGGINGS		Units / box 15
Art.No. 42001172		
Item specification		Pcs. / set
Table cover SOFT, 150 x 200cm		1
Mayo stand cover, 80 x 140 cm		1
Drape SOFT 230x250 cm, pelvis fenestration Ø 12cm with adhesive edge.		1
OP-tape, 10 x 50cm		1
Hand towel		2

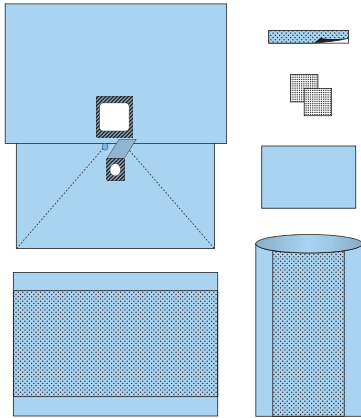

<b>HYSTERECTOMY SET WITH INTEGRAL LEGGINGS</b> Art.No. 42000 505		Units / box 10
Item specification	Pcs. / set	
Table cover, 150 x 200cm	1	
Mayo stand cover, 80 x 140 cm	1	
Drape SOFT 250x280 cm, abdominal fen. 30x30cm with adhesive edge, pelvis fenestration Ø 12cm covered with overlap.	1	
Drape SOFT, 50x70cm	1	
OP-tape, 10 x 50cm	1	
Hand towel	2	

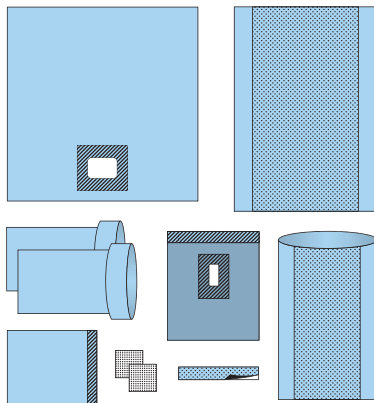

<b>HYSTERECTOMY SET III</b> Art.No. 42000 229		Units / box 8
Item specification	Pcs. / set	
Table cover, 150 x 190cm	1	
Mayo stand cover, 80 x 140 cm	1	
Leggings, 70 x 120 cm	2	
Abdominal drape SOFT 170 x 200cm, fen.30 x 30 cm, adhesive	1	
Pelviscopy drape ZR, 75 x 100 cm, fen. 6 x 14cm, adhesive	1	
Adhesive drape, 75 x 100 cm,	1	
OP-tape, 10 x 50cm	1	
Hand towel	2	

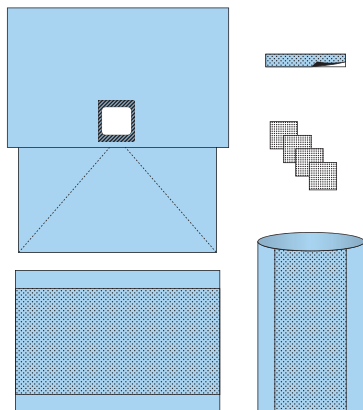

LAPAROSCOPY SET WITH INTEGRAL LEGGINGS Art.No. 42001163		Units / box 12
Item specification		Pcs. / set
Table cover SOFT, 150 x 200cm		1
Mayo stand cover, 80 x 140 cm		1
Drape SOFT 250x280 cm, abdominal fen. 30x30cm with adhesive edge		1
OP-tape, 10 x 50cm		1
Hand towel		4

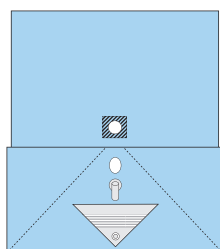

TUR DRAPE WITH INTEGRAL LEGGINGS		
Art. No.	Item specification	Qty./box
38345	Drape SOFT 190 x 230 cm with integral leggings equipped with fluid collection bag and latex examination finger coat.	20

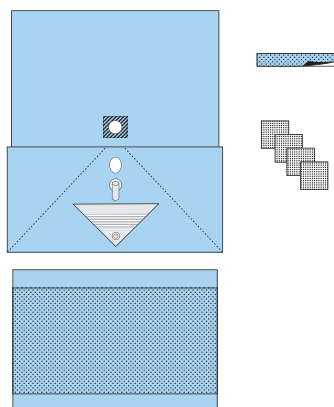

TUR SET Art.No. 42000 342		Units / box 15
Item specification		Pcs. / set
Table cover SOFT, 150 x 200cm		1
TUR drape SOFT 190 x 230 cm with integral leggings equipped with fluid collection bag and latex examination finger coat.		1
OP-tape, 10 x 50 cm		1
Hand towel		4

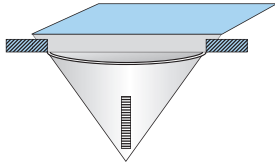

### UNDER BUTTOCK DRAPE

Art. No.	Item specification	Qty./box
DGUT70100S	Drape SOFT 50 x 100cm with fluid collection bag equipped with the 2500ml scale, formable reinforcement and two affixation tapes	50

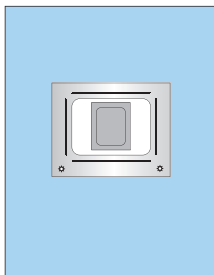

### C-SECTION DRAPE

Art. No.	Item specification	Qty./box
38227	Drape SMS 200 x 300cm with incise and fluid collection bag, fenestration 25 x 30 cm	15

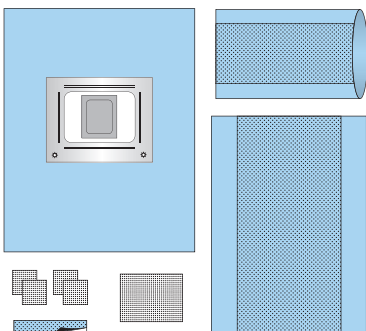

### C-SECTION SET Art.No. 42000 087

Item specification	Units / box 10 Pcs. / set
Table cover, 150 x 190cm	1
Mayo stand cover, 80 x 140 cm	1
Drape SMS 200 x 300cm with incise and fluid collection bag, fenestration 25 x 30 cm	1
Absorbent newborn drape, 70 x 80cm	1
OP-tape, 10 x 50cm	1
Hand towel	4

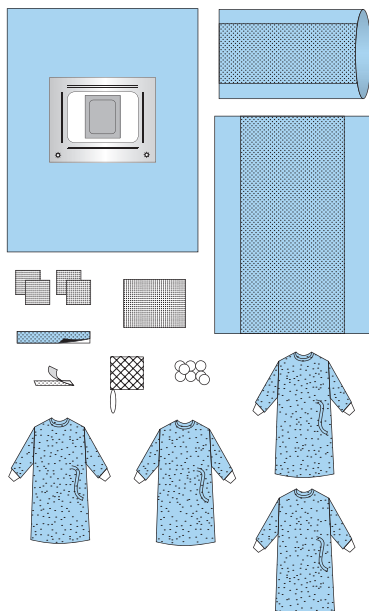

<b>C-SECTION SET SPECIAL</b> Art.No. 42000 272		<b>Units / box 4</b>
<b>Item specification</b>		<b>Pcs. / set</b>
Table cover, 150 x 190cm		1
Mayo stand cover, 80 x 140 cm		1
Surgical gown STANDARD, Size L		1
Surgical gown STANDARD, Size XL		3
Drape SMS 200 x 300cm with incise and fluid collection bag, fenestration 25 x 30 cm		1
Absorbent newborn drape, 70 x 80cm		1
OP-tape, 10 x 50cm		1
Velcro holder, 2 x 22cm		1
Gauze drape, X-ray detectable, 45 x 45cm		10
Gauze balls, 30 x 30cm		20
Hand towel		4

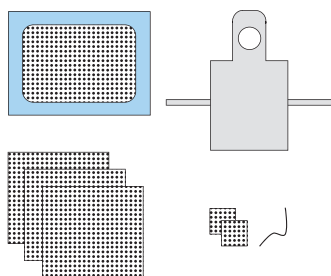

<b>NEWBORN SET</b> Art.No. 42000 091		<b>Units / box 25</b>
<b>Item specification</b>		<b>Pcs. / set</b>
Plastic apron, 80 x 130 cm		1
Absorbent underpad, 60 x 90cm		1
Absorbent newborn drape, 70 x 80cm		3
Absorbent towel, 30 x 30cm		2
Umbilical string, 1 x 20cm		1



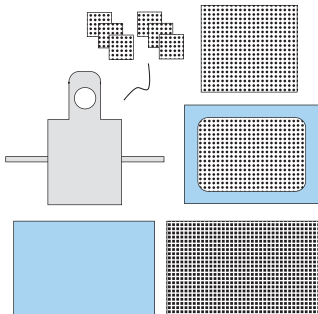

<b>DELIVERY SET 1</b> Art.No. 42000 089		Units / box 20
<b>Item specification</b>		<b>Pcs. / set</b>
Table cover SOFT, 100 x 120cm		1
Drape SOFT, 100 x 120 cm		1
Plastic apron, 80 x 130 cm		1
Absorbent underpad, 60 x 90cm		1
Absorbent newborn drape, 70 x 80cm		1
Absorbent towel, 30 x 30cm		6
Umbilical string, 1 x 20cm		1

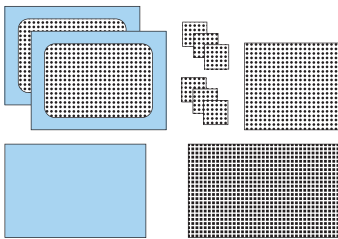

<b>DELIVERY SET 2</b> Art.No. 42000 090		Units / box 15
<b>Item specification</b>		<b>Pcs. / set</b>
Table cover SOFT, 100 x 120cm		1
Drape SOFT, 100 x 120 cm		1
Absorbent underpad, 60 x 90cm		2
Absorbent newborn drape, 70 x 80cm		1
Absorbent towel, 30 x 30cm		6

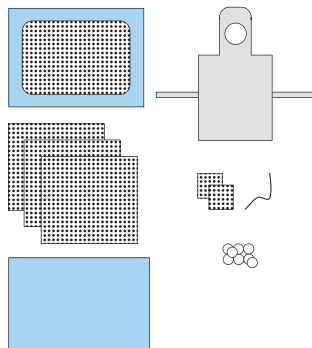

<b>DELIVERY SET 3</b> Art.No. 42323101		Units / box 20
<b>Item specification</b>		<b>Pcs. / set</b>
Drape SOFT, 100 x 120 cm		1
Plastic apron, 80 x 160 cm		1
Absorbent underpad, 60 x 90cm		1
Gauze balls, 40 x 40cm		10
Absorbent newborn drape, 70 x 80cm		3
Absorbent towel, 30 x 30cm		2
Umbilical string, 1 x 20cm		1

## OPERATING SETS – CARDIOVASCULAR SURGERY

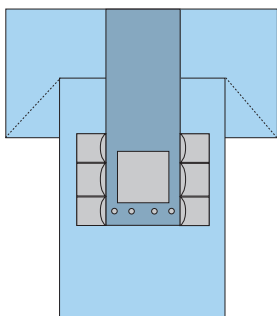

THORAX DRAPE		
Art. No.	Item specification	Qty./box
38321	Drape ZR 260x320 cm, with incise film, side pockets and cable holder. Abdominal fenestration 30x40cm	10

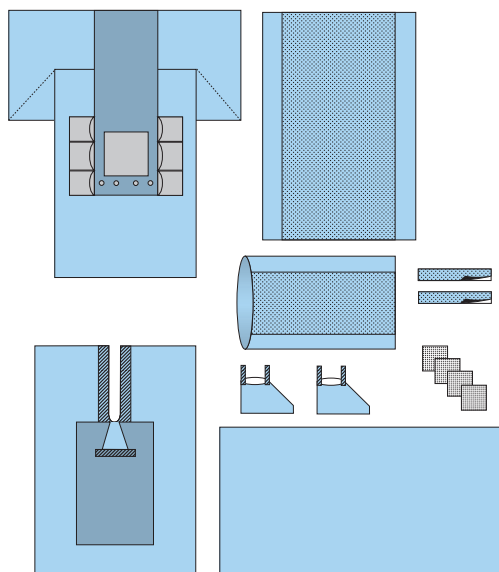

CARDIOVASCULAR SET BYPASS Art.No. 42000 341		Units / box 5
Item specification	Pcs. / set	
Table cover, 150 x 190cm	1	
Mayo stand cover, 80 x 140 cm	1	
Thorax drape ZR 260x320 cm, with incise film, side pockets and cable holder. Abdominal fenestration 30x40cm	1	
U-drape ZR with perineal cover, 200 x 260cm	1	
Drape T3, 150 x 180cm	1	
Boot, 25 x 35cm	2	
OP-tape, 10 x 50cm	2	
Hand towel	4	

## OPERATING SETS – NEUROLOGY

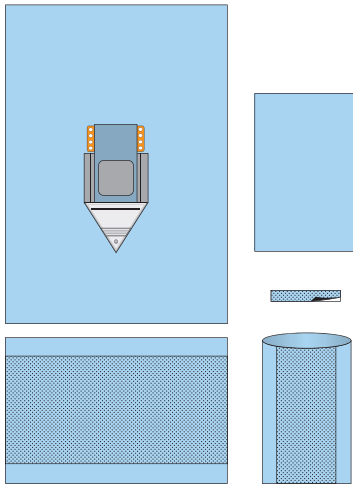

<b>CRANIOTOMY SET</b> Art.No. 42000 656		Units / box 12
<b>Item specification</b>		<b>Pcs. / set</b>
Table cover, 150 x 260cm		1
Mayo stand cover, 80 x 140 cm		1
Craniotomy drape ZR 200x280 cm, with fluid collection bag and cable holdem. Fenestration 22x22cm with integral incise film.		1
Drape SOFT, 100 x 150cm		1
OP-tape, 10 x 50cm		1

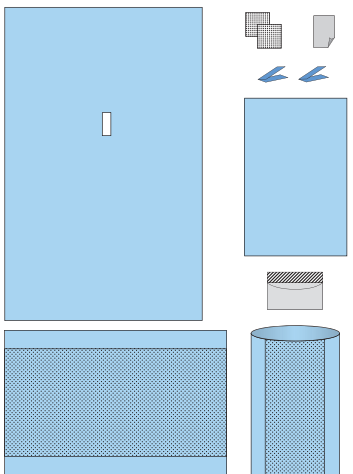

<b>SPINAL SURGERY SET</b> Art.No. 42001073		Units / box 10
<b>Item specification</b>		<b>Pcs. / set</b>
Table cover, 150 x 190cm		1
Mayo stand cover, 80 x 140 cm		1
Drape 150x300 cm, fenestration 6x10cm		1
Drape SOFT, 100 x 150cm		1
Incise film, 15x27cm		1
Fluid collection pouch, 25x26cm		1
Velcro holder, 2x22cm		2
Hand towel		2

## OPERATING SETS – CARDIOLOGY & ANGIOGRAPHY

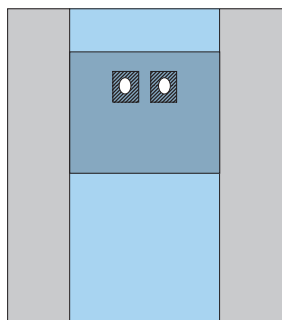

FEMORAL ANGIOGRAPHY DRAPE DOUBLE SIDE		
Art. No.	Item specification	Qty./box
38342	Drape ZR 240x320 cm, with two femoral fenestration 6x8cm and two side transparent covers for control panel	15

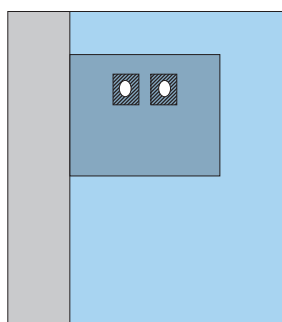

FEMORAL ANGIOGRAPHY DRAPE RIGHT SIDE		
Art. No.	Item specification	Qty./box
38343	Drape ZR 220x330 cm, with two femoral fenestration Ø9cm and one side transparent cover for control panel	12

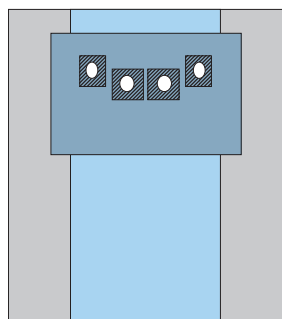

FEMORAL / RADIAL ANGIOGRAPHY DRAPE, DOUBLE SIDE		
Art. No.	Item specification	Qty./box
38344	Drape ZR 270x350 cm, with two femoral fenestration Ø9cm and two radial fenestration 9x12cm. Two side transparent covers for control panel	12

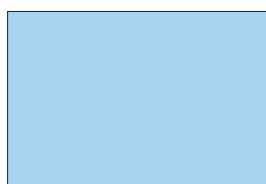
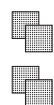
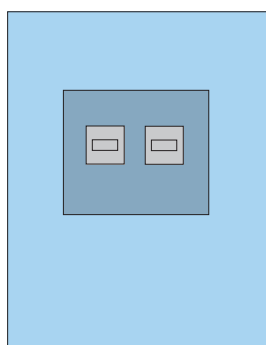

PACEMAKER SET		Units / box 10
Art.No. 42000 952		Pcs. / set
Table cover, 150 x 180 cm		1
Surgical gown STANDARD PLUS, size XXL		1
Drape ZR 200x300, two fenestrations 9x12cm with integral incise film		1
X-ray device cover, 140x140cm		1
X-ray device cover, 65x85cm		1
Hand towel		4



<b>ANGIOGRAPHY SET SPECIAL</b>	
<b>Art.No. 42000 407</b>	
<b>Item specification</b>	<b>Units / box 8</b>
<b>Item specification</b>	<b>Pcs. / set</b>
Table cover, 100 x 150 cm	1
Surgical gown STANDARD, size XL	1
Femoral angiography drape 200 x 320 cm, double side	1
X-ray device cover, 65 x 85cm	1
X-ray device cover, 70 x 80cm plochy	2
Bowl 500ml	2
Gallipot 125ml	1
Syringe 5ml	1
Syringe 20ml	1
Syringe 10ml Luer Lock	1
Needle 0,8x40mm	1
Introducer needle 18G, 1,2 x 70 mm	1
Sponge stick	2
Gauze swabs, 10x10cm	60
Hand towel	1

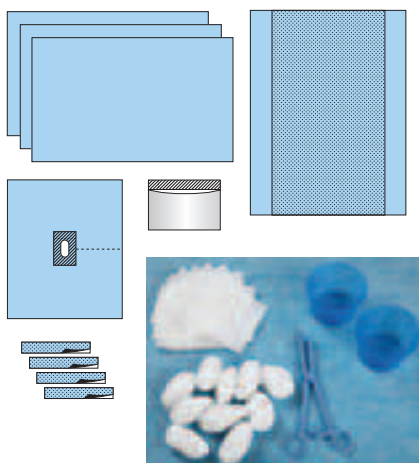

<b>CARDIAC CATHETRIZATION / BIOPSY SET</b>	
<b>Art.No. 42000 182</b>	
<b>Item specification</b>	<b>Units / box 12</b>
<b>Item specification</b>	<b>Pcs. / set</b>
Table cover, 100 x 150 cm	1
Drape, 100 x 150 cm	3
Fenestrated drape with radial perforation, Fenestration 6x8cm, adhesive	1
OP-tape, 10 x25cm	4
Fluid collection pouch, 30 x40cm	1
Bowl 250ml	2
Gauze swabs 10x10cm	15
Gauze balls 40x40cm	10
Swab clamp	1

## OPERATING SETS - OPHTHALMOLOGY

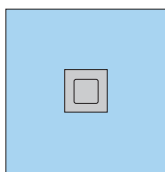

BASIC OPHTHALMOLOGY DRAPE		
Art. No.	Item specification	Qty./box
38310	Drape SMS 100 x 100 cm, fenestration 10x10cm with integral incise film	100

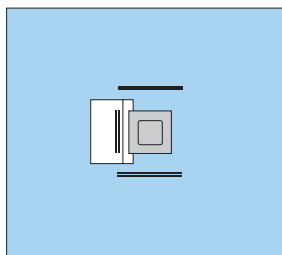

ONE SIDE OPHTHALMOLOGY DRAPE		
Art. No.	Item specification	Qty./box
38311	Ophthalmic drape SMS100 x 100 cm, with incise film, one fluid collection pouch and formable reinforcement. Fenestration 10x10cm	100

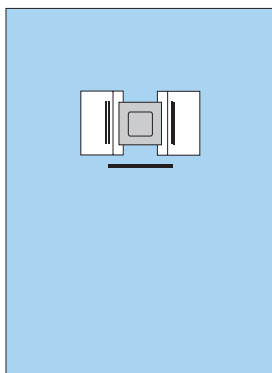

DOUBLE SIDE OPHTHALMOLOGY DRAPES		
Art. No.	Item specification	Qty./box
38312	Ophthalmic drape SMS 120 x 160 cm, with incise film, two fluid collection pouches and formable reinforcement. Fenestration 10x10cm	40
38318	Ophthalmic drape SMS 160 x 240 cm, with incise film, two fluid collection pouches and formable reinforcement. Fenestration 10x10cm	35

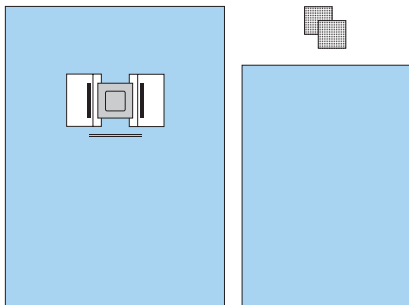

<b>OPHTHALMIC SET BASIC</b> Art.No. 42 000 072		Units / box 25
Item specification		Pcs. / set
Table cover, 100x150cm		1
Ophthalmic drape with incise fim and two F/c pouches, 120x160cm		1
Hand towel		2

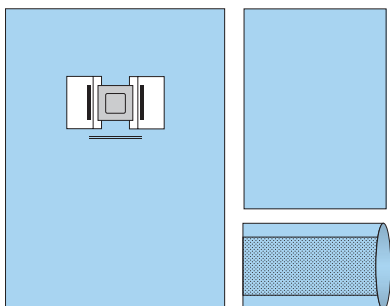

<b>UNIVERSAL OPHTHALMIC SET</b> Art.No. 42 000 073		Units / box 15
Item specification		Pcs. / set
Table cover, 100x150cm		1
Mayo stand cover, 80x140cm		1
Ophthalmic drape with incise fim and two F/c pouches, 120x160cm		1
Phaco tray cover, 40x65cm		1
Armboard cover, 35x75cm		2
Hand towel		2

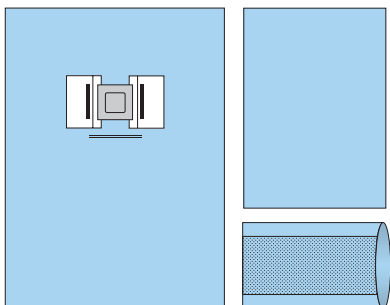
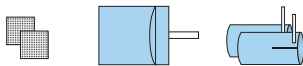

<b>OPHTHALMIC SET LARGE</b> Art.No. 42 000 074		Units / box 10
Item specification		Pcs. / set
Table cover, 100x150cm		1
Ophthalmic drape with incise fim and two F/c pouches, 160x240cm		1
Mayo stand cover, 80x140cm		1
Phaco tray cover, 40x65cm		1
Armboard cover, 35x75cm		2
Surgical gown STANDARD, size M		1
Surgical gown STANDARD, size XL		1
Hand towel		4

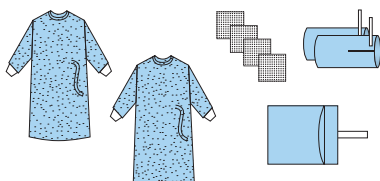



<b>INTRAVITREAL INJECTION SET</b> Art.No. 42 000 675		<b>Units / box 35</b>
<b>Item specification</b>	<b>Pcs. / set</b>	
Table cover, 75x75cm	1	
Plastic tray	1	
Cotton tipped sticks	2	
Sponge stick	1	
Gauze swabs, 10x10cm	5	
Caliber scleral marker, 3,5 / 4mm	1	
Eye speculum	1	
Patient drape 40x47cm with incise fim, fenestration 4x7cm	1	

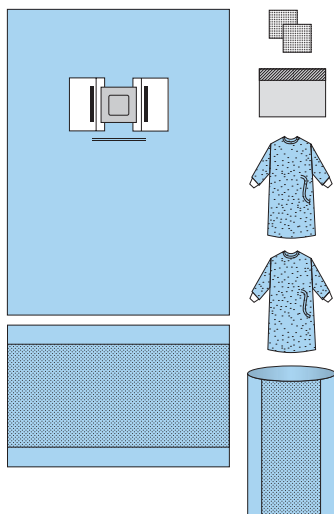

<b>CATARACT SET „UNI“</b> Art.No. 42 000 742		<b>Units / box 10</b>
<b>Item specification</b>	<b>Pcs. / set</b>	
Table cover, 150x190cm	1	
Ophthalmic drape with incise fim and two F/c pouches, 120x160cm	1	
Mayo stand cover, 60x100cm	1	
Screen cover, 50x50cm, transparent	1	
Gallipot 120ml with scale	2	
Plastic tray, 2-part	1	
Eye spears	5	
Eye swabs ProOphta	3	
Syringe 2,5ml, Luer Lock	1	
Syringe 5ml, Luer Lock	1	
Needle 27G, 0,4x25mm	1	
Hydrodissection cannula Sauter 27G	1	
Non-woven swabs 10x10cm	10	
Eye pad	1	
Eye shield, transparent	1	
Tegaderm 10x12cm	1	
Surgical gowns STANDARD, size XL	2	
Hand towel	2	



## OPERATING SETS – ENT

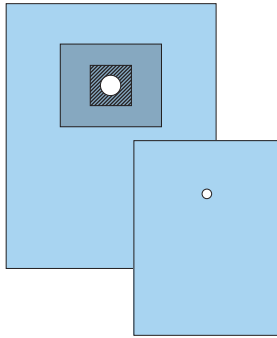

EXCENTRIC FENESTRATED DRAPES		
Art. No.	Item specification	Qty./box
38228	Drape SMS 120 x 160cm, fenestration ø 12 cm	60
38223	Drape ZR 200 x 280cm, fenestration ø 10cm, adhesive	20
38224	Drape ZR 200 x 280cm, fenestration ø 15cm, adhesive	20

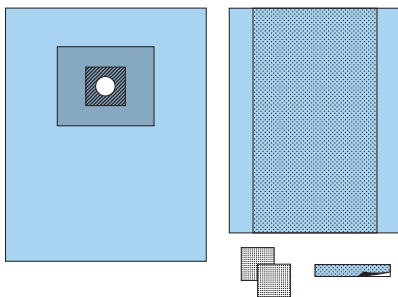

BASIC ENT SET Art.No. 42000 092		Units / box 14
Item specification	Pcs. / set	
Table cover, 150 x 190 cm	1	
Drape ZR, 200 x 280 cm, fenestration ø10 cm, adhesive	1	
OP-tape, 10 x 50cm	1	
Hand towel	2	

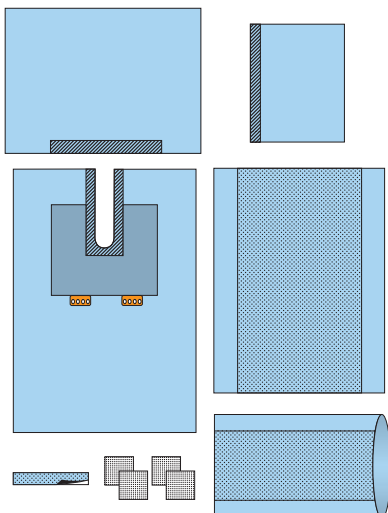

ENT U-SPLIT SET Art.No. 42000 093		Units / box 10
Item specification	Pcs. / set	
Table cover, 150 x 190 cm	1	
Mayo stand cover, 80 x 140 cm	1	
U-split drape ZR, 150 x 200cm	1	
Drape SOFT with adhesive edge, 150 x 180cm	1	
Drape SOFT with adhesive edge, 75 x 100cm	1	
OP-tape, 10 x 50cm	1	
Hand towel	4	

## CENTRAL VENOUS CATHETERIZATION SETS



<b>CENTRAL VENOUS CATHETER SET I</b> Art. No. 42000802		Units / box: 8
Item specification	Pcs. / set	
Wrapping sheet 100x120cm	1	
Table cover 150x190cm	1	
Surgical gown STANDARD size L	1	
Latex gloves, powder free, size M	4	
X-ray device cover 65x85cm	1	
X-ray device cover 140x140cm	1	
Bowl 250ml	1	
Bowl 500ml	2	
Adhesive fenestrated drape 75x90cm, fen. 6x8cm	1	
Drape 75x90cm	3	
Cotton gauze balls 40x40cm	20	
Cotton gauze swabs 10x10cm	25	
Kelly forceps 14cm, metal	1	
Scissors 13cm, sharp/dull edges, metal	1	
Scalpel no. 11	1	
Sponge forceps 19cm, plastic	1	
Syringe 10ml LS	2	
Needle 22G 0,7x30mm	1	
Needle 21G 0,8x40mm	1	



<b>CENTRAL VENOUS CATHETER SET II</b> Art. No. 42001462		Units / box: 12
Item specification	Pcs. / set	
Table cover 100x120cm	1	
Surgical gown STANDARD size L	1	
Gallipot 125ml	2	
Kidney bowl 750ml, plastic	1	
Adhesive fenestrated drape 75x100cm, fen. Ø 10cm	1	
Drape 100x120cm	1	
Cotton gauze balls 30x30cm	10	
Kelly forceps 14cm, metal	1	
Scissors 13cm, sharp/dull edges, metal	1	
Scalpel no. 11	1	
Needle holder 14cm, metal	1	
Syringe 10ml LS	4	
Needle 22G 0,7x30mm	1	
Needle 18G 1,2x40mm	1	

## NON-SURGICAL PROCEDURE SETS



UNIVERSAL PROCEDURE SET Art.No. 41001		Units / box 50
Item specification		Pcs. / set
Table cover, 50 x 50 cm		1
Latex gloves, powder free, size M		1 pair
Face mask with ear loops		1
Plastic forceps, fine tip		1
Non-woven swabs, 7,5 x 7,5cm		5
Non-woven balls, 20 x 20cm		5
Plastic tray, 2-chambers		1



SMALL PROCEDURE SET 1 Art.No. 41002		Units / box 50
Item specification		Pcs. / set
Table cover, 75 x 100 cm		1
Drape, 45 x 65cm, with fen. Ø 7,5cm		1
Non-woven swabs, 7,5 x 7,5cm		5
Non-woven balls, 20 x 20cm		5
Plastic tray, 2-chambers		1



SMALL PROCEDURE SET 2 Art.No. 41003		Units / box 50
Item specification		Pcs. / set
Table cover, 75 x 100 cm		1
Latex gloves, powder free, size M		1pair
Face mask with ear loops		1
Drape, 45 x 65cm, with fen. Ø 7,5cm		1
Non-woven swabs, 7,5 x 7,5cm		10
Non-woven balls, 20 x 20cm		5
Plastic tray, 2-chambers		1



SMALL PROCEDURE SET 4 Art.No. 41047		Units / box 50
Item specification		Pcs. / set
Table cover, 75 x 100 cm		1
Drape, 45 x 65cm, with fen. Ø 7,5cm		1
Non-woven swabs, 7,5 x 7,5cm		7
Non-woven balls, 20 x 20cm		7



<b>SMALL PROCEDURE SET 3</b> Art.No. 41025		<b>Units / box 30</b>
<b>Item specification</b>	<b>Pcs. / set</b>	
Table cover, 75 x 100 cm	1	
Plastic tray, 2-chambers	1	
Non-woven balls, 20x20cm	5	
Non-woven balls, 30x30cm	3	
Non-woven swabs, 7,5x7,5cm	5	
Plastic Kocher clamp	1	
Plaster Mepore, 9x10cm	1	
Drape, 75x100cm, with fenestration, 6x8cm, adhesive	1	



<b>URINAL CATHETRIZATION SET</b> Art.No. 41034		<b>Units / box 20</b>
<b>Item specification</b>	<b>Pcs. / set</b>	
Table cover, 90 x 90 cm	1	
Latex gloves, powder free, size M	1 pair	
Plastic forceps	1	
Non-woven balls, 20 x 20cm	4	
Syringe Luer 10ml	1	
Double chamber bowl	1	



<b>OPHTHALMIC SMALL PROCEDURE SET</b> Art.No. 41069		<b>Units / box 50</b>
<b>Item specification</b>	<b>Pcs. / set</b>	
Table cover, 75 x 100 cm	1	
Plastic tray, 1-chamber	1	
Drape, 75x100cm, with fenestration, 6x8cm, adhesive	1	
Syringe Luer 2ml	1	
Hypodermic needle 25G	1	
Gauze balls, 20 x 20cm	4	
Eye pad	1	
Gauze swabs, 5x5cm	20	



<b>WOUND RE-DRESSING SET</b> Art.No. 41019		<b>Units / box 70</b>
<b>Item specification</b>	<b>Pcs. / set</b>	
Plastic tray, 1-chamber	1	
Plastic forceps	1	
Non-woven swabs, 7,5 x 7,5cm	5	
Non-woven balls, 20 x 20cm	5	



<b>SUTURE REMOVAL SET</b> Art.No. 41005		Units / box 70
Item specification	Pcs. / set	
Suture removal knife	1	
Non-woven swabs, 7,5 x 7,5cm	3	
Plastic forceps	1	

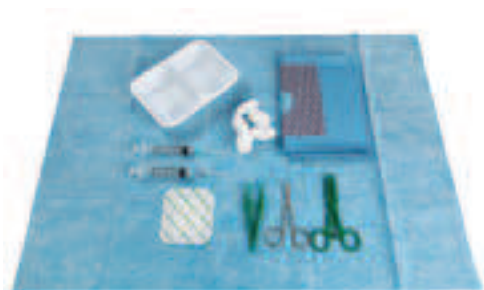

<b>SUBCLAVIA SET</b> Art.No. 41007		Qty./box 35
Item specification	Pcs. / set	
Table cover, 75 x 100 cm	1	
Plastic tray, 2-chambers	1	
Non-woven balls, 20x20cm	5	
Syringe 10ml Luer Lock	2	
Hypodermic needle 21G	1	
Hypodermic needle 22 G	1	
Plastic forceps	1	
Scissors	1	
Plastic Kocher clamp	1	
Plaster Mepore, 9x10cm	1	
Drape, 75x100cm, with fenestration, 6x8cm, adhesive	1	



<b>SUBCLAVIA SET 2</b> Art.No. 41024		Units / box 30
Item specification	Pcs. / set	
Table cover, 75 x 100 cm	1	
Plastic tray, 2-chambers	1	
Plastic tray, 1-chamber	1	
Non-woven balls, 20x20cm	5	
Non-woven balls, 30x30cm	3	
Non-woven swabs, 10x10cm	5	
Plastic forceps	1	
Scissors	1	
Plastic Kocher clamp	1	
Plaster Mepore 9x10cm	1	
Drape, 75x100cm, with fenestration, 6x8cm, adhesive	1	



<b>EPIDURAL SET 2</b> Art.No. 41041		<b>Units / box 20</b>
<b>Item specification</b>	<b>Pcs. / set</b>	
Table cover, 100 x 120 cm	1	
Epidural drape, adhesive, fen. 6x15cm	1	
Plastic tray, 1-chamber	1	
Latex gloves, powder free, size M	1 pair	
Gauze balls, 30x30cm	6	
Gauze swabs, 10x10cm	6	
Plastic Kocher clamp	1	
Syringe 5ml	1	
Hypodermic needle 18G	1	
Hypodermic needle 22G	1	



<b>ANAESTHESIA SET 1</b> Art.No. 41014		<b>Units / box 50</b>
<b>Item specification</b>	<b>Pcs. / set</b>	
Table cover, 100 x 100 cm	1	
Drape, 75x100	2	
Drape, 45 x 65cm, with fen. Ø 7,5cm	1	
Syringe 10ml	1	
Syringe 5ml	1	
Cotton tipped sticks, small head	2	
Gauze swabs, 7,5x7,5cm	2	
Gauze balls, 30x30cm	5	
Plastic Kocher clamp	1	



<b>ANAESTHESIA SET 3</b> Art.No. 41027		<b>Units / box 20</b>
<b>Item specification</b>	<b>Pcs. / set</b>	
Table cover, 75 x 100 cm	1	
Plastic tray, 2-chambers	1	
Non-woven balls, 20x20cm	5	
Non-woven swabs, 7,5x7,5cm	5	
Hypodermic needle 18G	1	
Hypodermic needle 22G	1	
Plastic Kocher clamp	1	
Drape, 75x100cm, with fenestration 6x8cm, adhesive	1	



## SURGICAL GOWNS AND SCRUB SUIT



**SURGICAL GOWN „STANDARD“**  
 - Made of SMS polypropylene non-woven fabric of 45gr./sqm.  
 - Sleeves are edged with knitted cuffs

Art. No.	Item specification	Qty./box
21920	Surgical Gown „STANDARD“, size. M	25
21921	Surgical Gown „STANDARD“, size. L	25
21922	Surgical Gown „STANDARD“, size. XL	25
21923	Surgical Gown „STANDARD“, size.XXL	25

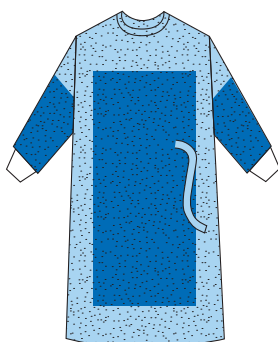

**SURGICAL GOWN „STANDARD PLUS“**  
 - Same as STANDARD, equipped with fluid resistant reinforcement on the front side and sleeves

Art. No.	Item specification	Qty./box
21931	Surgical Gown „STANDARD PLUS“, size. L	25
21932	Surgical Gown „STANDARD PLUS“, size. XL	25
21933	Sgcl. gown STANDARD PLUS“, size.XXL	25

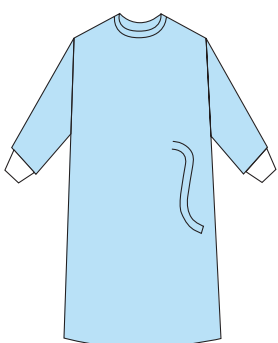

**SURGICAL GOWN „COMFORT“**  
 - Made of hydrophobic spunlace non-woven fabric 70gr./sqm.  
 (55% woodpulp, 45 % PES)  
 - Sleeves are edged with knitted cuffs

Art. No.	Item specification	Qty./box
21900	Surgical Gown „COMFORT“, size. M	25
21901	Surgical Gown „COMFORT“, size. L	25
21902	Surgical Gown „COMFORT“, size. XL	25
21903	Surgical Gown „COMFORT“, size.XXL	25

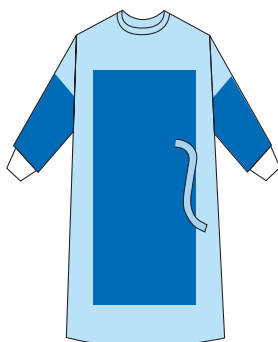

**SURGICAL GOWN „COMFORT PLUS“**  
 - Same as COMFORT, equipped with fluid resistant reinforcement on the front side and sleeves

Art. No.	Item specification	Qty./box
21911	Surgical Gown „COMFORT PLUS“, size. L	25
21912	Surgical Gown „COMFORT PLUS“, size. XL	25
21913	Surgical Gown „COMFORT PLUS“, size.XXL	25





**MEDISET**

- Disposable blouse and trousers for OR staff
- Made of SMS polypropylene non-woven fabric 45 gr./sqm.
- Blouse is equipped with two pockets
- Trousers with waist string

Art. No.	Item specification	Qty./box
21700	MEDISET, size M	50
21701	MEDISET, size L	50
21702	MEDISET, size XL	50

## DISPOSABLE APPAREL AND PROTECTIVE AIDS



**DOC**

- Male surgical cap with tie tapes
- Made of air-permeable absorbent non-woven fabric
- Equipped with sweatband

Art. No.	Item specification	Qty./box
21220	Surgical cap DOC, blue	300



**POLLY**

- Female surgical cap with tie tapes
- Made of air-permeable absorbent non-woven fabric

Art. No.	Item specification	Qty./box
21221	Surgical cap POLLY, blue	300



**BOUFFANT CAP “CLIP”**  
 - Disposable head cover edged with elastic string  
 - Length 53 cm  
 - made of spunbond polypropylene non-woven 14 gr./Sqm.  
 - Packed in polybag by 100 Pcs.

Art. No.	Item specification	Qty./box
21210	Bouffant cap CLIP, white	1000
21211	Bouffant cap CLIP, green	1000



**BOUFFANT CAP “BARETT”**  
 - disposable head cover of round shape, equipped with elastic hem,  
 - diameter 54 cm  
 - made of spunbond polypropylene non-woven 18 gr./Sqm.  
 - packed in dispenser box by 100 pcs.

Art. No.	Item specification	Qty./box
21201	Bouffant cap BARETT, white	1000
21200	Bouffant cap BARETT, green	1000



**SURGICAL FACE MASK**  
 - 3-layer surgical face mask with high filtration efficiency  
 (BFE over 98%,  $\Delta P$  3,0  $\mu m$  H<sub>2</sub>O/cm<sup>2</sup>)  
 - free of latex, glass fibres and other allergenic substances, odourless, gentle to the skin  
 - equipped with metallic nosepiece allowing perfect anatomic shaping  
 - affixation with tie-tapes or ear-loops

Art. No.	Item specification	Qty./box
21100	Face mask green, with tie-tapes	1000
21101	Face mask green, with ear-loops	1000



#### ISOLATION GOWNS

- single use isolation gown with two pairs of tie tapes
- made of spunbond polypropylene non-woven, 25 gr./Sqm.

Art. No.	Item specification	Qty./box
21500	XL size (120 x 140cm), white sleeves edged with elast. band	100
21501	XL size (120 x 140cm), green sleeves edged with elast. band	100
21511	XL size (120 x 140cm), green sleeves edged with knitted cuffs	100



#### APRON

- disposable apron of with two tie tapes
- made of white polyethylene film 30µm

Art. No.	Item specification	Qty./box
21600	PE Apron white, 80 x 130 cm	1000
21601	PE Apron, 80 x 160 cm	500



#### SHOE COVERS

- Bundled by 10 pcs, packed by 100 Pcs in polybag

Art. No.	Item specification	Qty./box
21300	Shoe cover PP – non-woven, white	1000
21400	Shoe cover CPE – plastic film, blue	2000